



AUTOMATIC ENTRANCE SPECIALISTS



D2H - D2HL

IP1586
rev. 2007-06-12

- I** Manuale di installazione quadro elettronico per automazione 24V= a 1 o 2 motori
- GB** Electric board installation handbook for 24V= automation with 1 or 2 motors
- F** Notice d'installation armoire électrique pour automatisation 24V= à 1 ou 2 moteurs
- D** Installationsanleitung der ein- oder zweimotorigen Torsteuerung 24V=
- E** Manual de instalación del tablero eléctrico para automatización 24V= a 1 o 2 motores
- P** Manual de instalação quadro eléctrico para automatismos 24V= com 1 o 2 motores

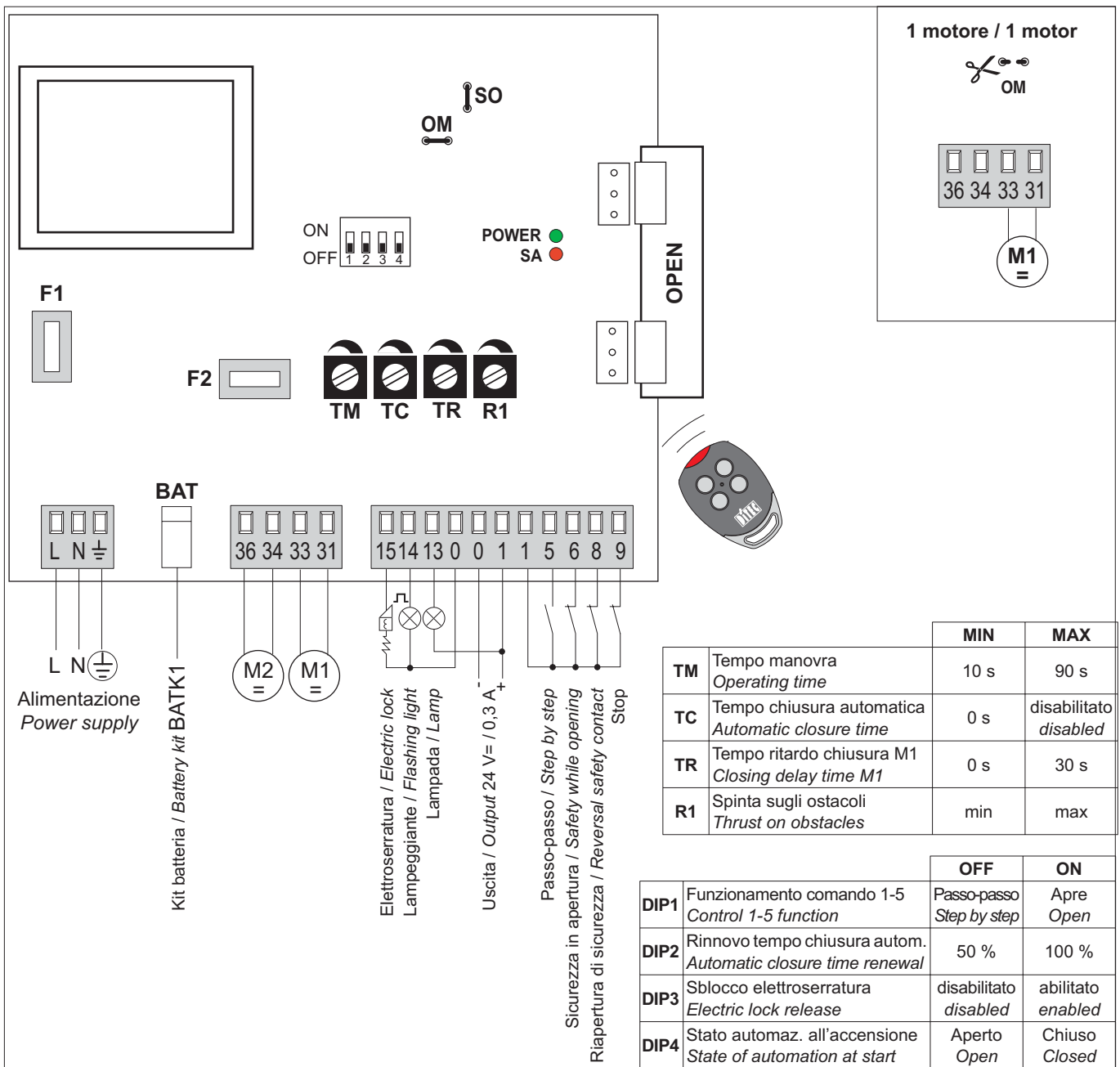

DITEC S.p.A.
Via Mons. Banfi, 3 - 21042 Caronno Pertusella (VA) - ITALY
Tel. +39 02 963911 - Fax +39 02 9650314
www.ditec.it - ditec@ditecva.com

ISO 9001
Cert. n° 0957

GENERAL SAFETY PRECAUTIONS

 This installation manual is intended for professionally competent personnel only.

The installation, the power connections and the settings must be completed in conformity with Good Working Methods and with the regulations in force. Before installing the product, carefully read the instructions. Bad installation could be hazardous.

The packaging materials (plastic, polystyrene, etc.) should not be discarded in the environment or left within reach of children, as these are a potential source of hazard. Before beginning the installation check that the product is in perfect condition.

Do not install the product in explosive areas and atmospheres: the presence of flammable gas or fumes represents a serious threat to safety.

The safety devices (photocells, sensitive edges, emergency stop, etc.) must be installed taking into account: the provisions and the directives in force, Good Working Methods, the installation area, the functional logic of the system and the forces developed by the motorised door or gate.

 Before making power connections, check that the rating corresponds to that of the mains supply A multipolar disconnection switch with a contact opening gap of at least 3 mm must be included in the mains supply. Check that upstream of the electrical installation an adequate residual current circuit breaker and an overcurrent cut out are fitted. When requested, connect the motorised door or gate to an effective earthing system carried out as indicated by current safety regulations. During installation, maintenance and repair operations, cut off the power supply before opening the cover to access the electrical parts.

 To handle electronic parts, wear earthed antistatic conductive bracelets. The manufacturer of the motorisation declines all responsibility in the event of components which are not compatible with the safe and correct operation of the product. For repairs or replacements of products only original spare parts must be used.

INSTALLATION WARNING

Secure the control panel permanently. Drill a hole into the lower side of the container so as to run the cables through it. Secure the cables, if they are accessible, by means of appropriate gland plates (not provided by us). Keep the line conductors separate from the motor and the control conductors (at least 8 mm) at the terminal board connection points (for example, by means of clamps). Connect the line and motor protection conductors (yellow-green) by means of the transformer and control panel using the clamp provided. At the end of the installation to close again the container.

EC DECLARATION OF CONFORMITY

Manufacturer: DITEC S.p.A. via Mons. Banfi, 3
21042 Caronno Pertusella (VA) – ITALY.
Herewith declares that the control panel D2H/D2HL is in conformity with the provisions of the following EC directives:
Low Voltage Directive 73/23/EEC;
EMC Directive 89/336/EEC.

Caronno Pertusella,
17-05-2007

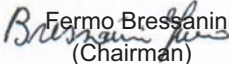
Fermo Bressanini
(Chairman)

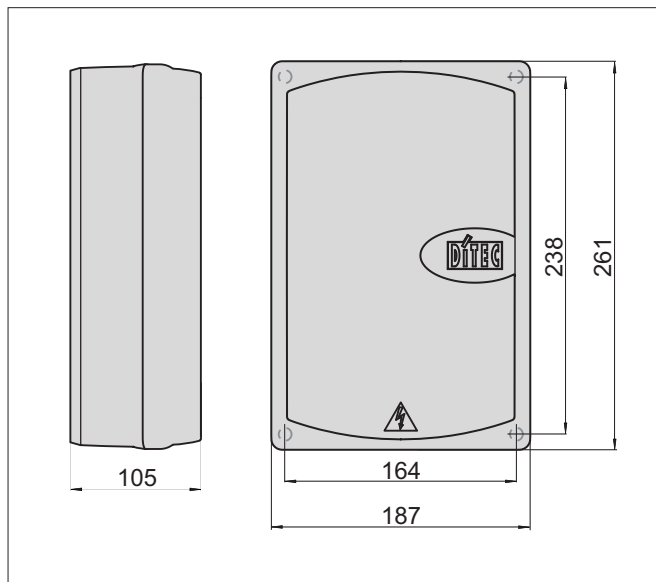

APPLICATIONS

D2H

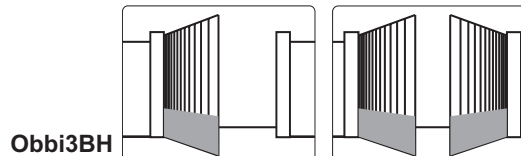

D2HL

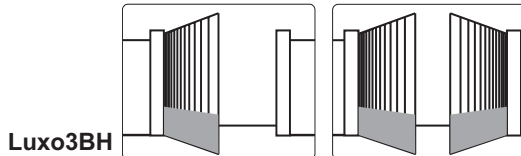

TECHNICAL DETAILS

	D2H / D2HL	D2HJ
Power supply	230 V~ / 50-60 Hz	120 V~ / 50-60 Hz
Fuse F1	F1.6A	F3.15A
Fuse F2	F2.5A	F2.5A
Motor output	24 V= 2x4.5 A max	24 V= 2x4.5 A max
Accessories power supply	24 V= / 0,3 A	24 V= / 0,3 A
Temperature	-20° C / +55° C	-20° C / +55° C
Protection degree	IP55	IP55
Dimensions	187x261x105	187x261x105

All rights reserved

All data and specifications have been drawn up and checked with the greatest care. The manufacturer cannot however take any responsibility for eventual errors, omissions or incomplete data due to technical or illustrative purposes.

1. ELECTRICAL CONNECTIONS

1.1 Commands

Command	Function	Description
	N.O.	STEP BY STEP WITH AUTOMATIC CLOSING With DIP1=OFF and TC<MAX, the closure of the contact activates an opening or closing operation in the following sequence: open-stop-close-open. <i>Note: the stop is not permanent, but has the duration set by TC.</i>
		STEP BY STEP WITHOUT AUTOMATIC CLOSING With DIP1=OFF and TC=MAX, the closure of the contact activates an opening or closing operation in the following sequence: open-stop-close-open.
		OPENING WITH AUTOMATIC CLOSING With DIP1=ON and TC<MAX, the closure of the contact activates an opening operation.
		OPENING WITHOUT AUTOMATIC CLOSING With DIP1=ON and TC=MAX, the closure of the contact activates an opening operation. With the automation blocked, the closure of the contact activates the opposite operation compared with that activated before the stop.
	N.C.	SAFETY STOP Opening the safety contact stops the current operation in progress and impedes any future opening operations.
	N.C.	REVERSAL SAFETY Opening the safety contact triggers a reversal of the movement (reopening) during a closing operation. With SO=ON with the automation stopped, the opening of the contact prevents any operation. With SO=OFF with the automation stopped, the opening of the contact only prevents the closing operation.
	N.C.	STOP Opening the safety contact stops the current opening operation in progress. The automatic closing are disabled. <i>N.B. If present, the flashing light blinks.</i>
COUPLING BOARD (OPEN)	STEP BY STEP / OPEN	It has the same function as contact 1-5.



WARNING: Make a jumper on all NC contacts if not in use. The terminals with the same number are equal. The given operating and performance features can only be guaranteed with the use of DITEC accessories and safety devices.

1.2 Outputs and accessories

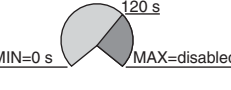
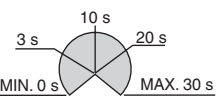

Output	Value	Description
	24V= / 0,3 A	Accessories power supply. Power supply output for external accessories, including automation status lamp..
	24V= / 30 W (1,25 A)	Flashing light (LAMPH). Activated during opening and closing operations. During an automatic closing procedure the blinking phase begins 3 s before the time set on TC expires; if TC< 3 s, the preliminary blinking phase continues throughout the entire standstill time. Protected exit with fuse F2.
	12V~ / 15 W	12 V electric lock. Connect the supplied 8.2 Ω / 5 W resistance in series. Activated upon every opening command. Protected exit with fuse F2.
	24V= / 3 W (0,125 A)	Automation open lamp. A lamp lights up that extinguishes only when automation is closed.
BAT		Battery operation (BATK1). An optional battery kit is available including a control circuit and battery charger. The batteries are kept charged when the power supply is on. If the power supply is off, the panel is powered by the batteries until the power is re-establish or until the battery voltage drops below the safety threshold. The panel turns off in the last case. <i>Attention: the batteries must always be connected to the control panel for charging. Periodically check the efficiency of the batteries.</i> <i>Note: the operating temperature of the rechargeable batteries is approximately +5°C/+40°C. The batteries should be installed inside a climatized environment to ensure the correct functioning of the product.</i>

2. SETTINGS



2.1 Trimmer

Trimmer	Description
TM  <p>MIN=10 s 30 s MAX=90 s</p>	Setting the operating time. From 10 to 90 s.
TC  <p>MIN=0 s 120 s MAX=disabled</p>	Setting automatic closing time. From 0 to 120 s. The count begins from the blocking of the automation, for the time set by the TC. With DIP2=OFF, once a safety switch has been activated, the counter starts as soon as the safety switch is released (for example, after passing through the photocells), and lasts for a period of time set with TC (50%). With DIP2=ON, the counter starts when automation is opened and lasts for the entire duration set with TC (100%). <i>Note: after the activation of the stop command, once contact 1-9 has closed again, automatic closing is only enabled after a step-by-step command.</i>
TR  <p>3 s 10 s 20 s MIN. 0 s MAX. 30 s</p>	Setting motor 1 (M1) closing delay time. When closing, motor 1 (M1) starts after a delay set with TR from 0 to 30 s relative to M2. When opening, motor 2 (M2) starts after a delay of 3 s relative to M1. If TR=MIN, the door wings start simultaneously. <i>Note: we recommend setting TR=MIN with non-overlapping door wings, and setting TR>3 s with overlapping door wings.</i>
R1  <p>MIN MAX=disabled</p>	Setting obstacle thrust. The control panel is equipped with a safety system that stops motion if an obstacle is encountered during an opening and closing operation. R1=MIN gives maximum obstacle sensitivity (minimum thrust). R1=MAX disables detection (maximum thrust).

2.2 Dip-Switch

	Description	OFF 	ON 
DIP1	Control 1-5 function	Step by step	Opening
DIP2	Restore automatic closing time	50%	100%
DIP3	Electric lock release.	Disabled	Enabled
DIP4	Automation status at power on. Indicates how the control panel considers automation when powered up.	Open. <i>Note: When DIP1=ON and TC<MAX the first command executes only the automatic closing procedure</i>	Close. <i>Note: the automatic closing will not be the first command, even if enabled. If the automatic closing function is not used, preferably set DIP4=ON.</i>

2.3 Bridges

	Description	OFF 	ON 
SO	Reversal safety functions	With automation stopped and contact 1-8 open, opening operations are permitted.	With automation stopped and 1-8 open, all operations are disabled.
OM	Automation type.	One motor automation (M1 only).	Automation with two independent motors.

2.4 Signals

LED	ON	Flashing
POWER	24 V= power supply.	/
SA	Indicates that at least one of the safety contacts is open.	/

3. STARTING

- 3.1 Close the leaves of the automation manually.
- 3.2 Bridge the NC safety contacts with a jumper.
- 3.3 Before starting up, check the application type selected. In the case of single door wing automation, cut the OM bridges.
- 3.4 Set TC and R1 at maximum and TR at minimum (or increase TR if the wing doors are overlapped).
- 3.5 Switch on power.

WARNING: The following operations are performed with no safety devices.



Swap the motor polarity if the direction of motion of the door wings is incorrect.

Warning: the first closing manoeuvre after a break in power supply is to be carried out on one door wing at a time (first the leaf moved by motor M2 and then the one moved by motor M1).

When the opening maneuver is defined by a limit stop, trimmer TM should be set in such a way that the time of the moving procedure takes 2-3 s longer than the time required for the automation to be opened completely.

When the opening maneuver is not defined by a limit stop, trimmer TM should be set in such a way that the desired distance of opening is reached.

Set trimmer TR in such a way that the leaves of the automation close again by folding over one another correctly (also when the direction is reversed). Check that the automation is functioning correctly by means of consecutive step commands.

- 3.6 Connect the safety devices (removing the relative jumpers) and check that they function correctly.

- 3.7 If required, regulate the automatic closing by means of the TC trimmer.

Warning: the automatic closing time after a safety is activated depends on the DIP2 setting.

- 3.8 Set the thrust on obstacles with R1.

Warning: if the leaf that closes last (TR > MIN) encounters an obstacle, both leaves open again. The following manoeuvre is performed one leaf at a time.

Note: check that the operating force of the leaves conform to that stipulated by the EN12453-EN12445 standards.

- 3.9 Connect any other accessories and check operation.

- 3.10 Once the start up and check procedures are completed, close the container.

4. TROUBLESHOOTING

Problem	Possible causes	Remedy
The automation does not open nor close.	No power supply.	Make sure the control panel is powered (the POWER LED must be on steady).
	Motor(s) not connected.	Check the motor(s) connection and the OM jumper (POWER LED flashing).
	Accessories short circuit.	Disconnect all the accessories from the terminals 0-1 (24V DC is required) and reconnect these one at a time.
	Line fuse is burnt.	Replace fuse F1.
	Safety controls are open. (SA LED is lit).	Make sure contacts 1-6, 1-8 and 1-9 are closed (N.C.). With a tester, make sure the power supply is 24V DC between 0-6, 0-8 and 0-9.
The automation opens but does not close.	Safety controls are open. (SA LED is lit).	Make sure contacts 1-6, 1-8 and 1-9 are closed (N.C.). With a tester, make sure the power supply is 24V DC between 0-6, 0-8 and 0-9.
	The photocells are triggered. (SA LED on).	Check that the photocells are clean and work properly.
External safety devices fail to operate.	Wrong connections between the control panel and the photocells.	Connect N.C. safety contacts in series and remove any jumpers on the terminal block of the electric control panel.
The flashing light is not working.	Fuse F2 burnt out.	Replace fuse F2.
The electric lock is not working.		